

**SKF**



# SKF TKSA 51

Instructions for use



## Table of contents

<b>EC Declaration of conformity .....</b>	<b>4</b>
<b>Safety recommendations .....</b>	<b>5</b>
<b>1. Introduction .....</b>	<b>6</b>
1.1 Shaft alignment overview.....	6
1.2 Principle of operation.....	7
1.3 Case content.....	8
1.4 Pre-alignment.....	9
<b>2. The measuring units .....</b>	<b>10</b>
2.1 Description.....	10
2.2 Handling the measuring units .....	11
2.3 Setup techniques .....	12
2.4 Setup .....	13
<b>3. Using the App.....</b>	<b>14</b>
3.1 App installation .....	14
3.2 App language & date format.....	14
3.3 Main menu.....	14
3.4 Settings .....	15
3.5 Select units.....	17
3.6 Machine information .....	18
3.7 Sensor status .....	21
3.8 Measuring procedure .....	23
3.9 "As found" measuring results .....	27
3.10 Vertical correction.....	28
3.11 Horizontal correction.....	29
3.12 Verify the alignment.....	31
3.13 "As corrected" measuring results .....	31
3.14 Report.....	31
<b>4. Technical specifications.....</b>	<b>33</b>

## EC Declaration of conformity

We,  
SKF Maintenance Products  
Kelvinbaan 16  
3439 MT Nieuwegein  
The Netherlands

herewith declare that the following product:

### **SKF Shaft Alignment Tool TKSA 51**

has been designed and manufactured in accordance with:  
EMC DIRECTIVE 2004/108/EC as outlined in the harmonized norm  
EN 61326-1:2013 Class B, group 1 equipment  
CISPR 11:2009 Class B, group 1  
IEC 61000-4-2:2009  
IEC 61000-4-3:2006

EUROPEAN ROHS DIRECTIVE 2011/65/EU

The laser is classified in accordance with the EN 60825-1:2007.  
The laser complies with 21 CFR 1040.10 and 1040.11 except for  
deviations pursuant to Laser Notice No. 50, dated June 24, 2007.

The enclosed device complies with Part 15 of the FCC Rules.  
47CFR: 2011 Part 15 Sub Part B Unintentional Radiators  
Contains FCC ID: QOQBLE112. Certification Number IC: 5123A-BGTBLE112  
Manufacturer's Name, Trade Name or Brand Name: bluegiga  
Model Name: BLE112-A

Nieuwegein, The Netherlands,  
May 2015



Sébastien David  
Manager Product Development and Quality



### Safety recommendations

- Read and follow all warnings in this document before handling and operating the equipment. You can be seriously injured, equipment and data can be damaged if you do not follow the safety warnings.
- Always read and follow the operating instructions.
- The equipment should not be used in areas where there is a risk of explosion.
- The tool uses two laser diodes with an output power below 1 mW. Still, never stare directly into the laser transmitter.
- Never aim the laser line into someone's eyes.
- The Measuring Units contains Lithium batteries. Do not expose the device to extreme heat.
- Do not charge the Measuring units below +4 °C (+40 °F) or above +45 °C (+113 °F).
- Dress properly. Do not wear loose clothing or jewellery. Keep your hair, clothing, and gloves away from moving parts.
- Do not overreach. Keep proper footing and balance at all times to enable better control of the device during unexpected situations.
- Use safety equipment. Non-skid safety shoes, hard hat or hearing protection must be used for appropriate conditions.
- Never work on energized equipment unless authorized by a responsible authority. Always turn off the power of the machine before you start.
- Do not expose the equipment to rough handling or impacts this will void the warranty.
- Avoid direct contact with water, wet surfaces, or condensing humidity.
- Do not attempt to open the device.
- Use only accessories that are recommended by SKF.
- Device service must be performed only by qualified SKF repair personnel.
- We recommend calibrating the tool every 2 years.

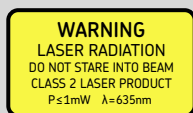

# 1. Introduction

## 1.1 Shaft alignment overview

Shaft misalignment is one of the most significant and most preventable contributors to premature machine failure. When a machine is placed in service with less than optimal shaft alignment, the following conditions are likely:

- Poor machine performance
- Increased power consumption
- Increased noise and vibration
- Premature bearing wear
- Accelerated deterioration of gaskets, packing, and mechanical seals
- Higher coupling wear rates
- Increased unplanned downtime

Proper alignment is achieved when the centerlines of each shaft are co-linear when the machine is under load and at normal operating temperatures. This is often referred to as shaft-to-shaft alignment. If the shafts of a machine train are not colinear, when the machine is in operation, they are misaligned.

In essence, the objective is to have a straight line through the centers of all of the shafts of the machines.

The SKF Shaft Alignment for TKSA 51 is a wireless shaft alignment tool that allows an easy and accurate method for aligning the shafts of a driving machine (e.g. electric motor) and a driven machine (e.g. pump).



## 1.2 Principle of operation

The TKSA 51 is a Line Laser Shaft Alignment System and it has two measuring units that are mounted on each shaft, or on each side of the coupling. After rotating the shafts into different measuring positions, the system calculates offset and angular misalignment values between the shafts. The values are compared with user defined tolerance limits and adjustments of the machine can be made instantly.

During the measuring procedure, measurements are taken in three positions, each separated by at least 20°. As the shafts are rotated through an arc, any parallel misalignment or angular misalignment causes the detectors to measure the difference in their positions relative to each other.

Positioning information from the measuring units is wirelessly communicated through Bluetooth Low Energy to the displaying device, which calculates the amount of shaft misalignment and advises corrective adjustments of the machine feet.

If the shafts of a machine train are not co-linear when the machine is in operation, they are by definition misaligned. While the actual shaft positions can be illustrated in three-dimensional space and the centerlines can be defined mathematically, it is easier to relate the relationship between shafts at the coupling as an offset, an angle, or any combination of the two in the vertical and horizontal axes.

### 1.3 Case content

The TKSA 51 case contains:



1. 2 × Measuring units	7. 1 × Micro USB to USB split charging cable
2. 2 × Shaft brackets with chains	8. 1 × 3m metric and imperial measuring tape
3. 2 × Extension chains	9. 1 × Certificate of calibration and conformance
4. 4 × Extension rods	10. 1 × Quick start guide (English)
5. 8 × Magnets	11. 1 × Warranty card
6. 1 × Plastic box with bolts for four magnets	

The carrying case is prepared with space for an iPad mini, including its charger.



## 1.4 Pre-alignment

Ensure that all precautions are taken to prevent the machine from accidentally being started. Lock out / tag out all machines before use.

### Check:

- Shim size
- Required tolerances
- Coupling play
- Pipe strain
- Mechanical looseness
- Soft foot



## 2. The measuring units

### 2.1 Description

The measuring unit marked S (stationary) should be mounted on the stationary machine and the unit marked M (movable) on the movable machine.

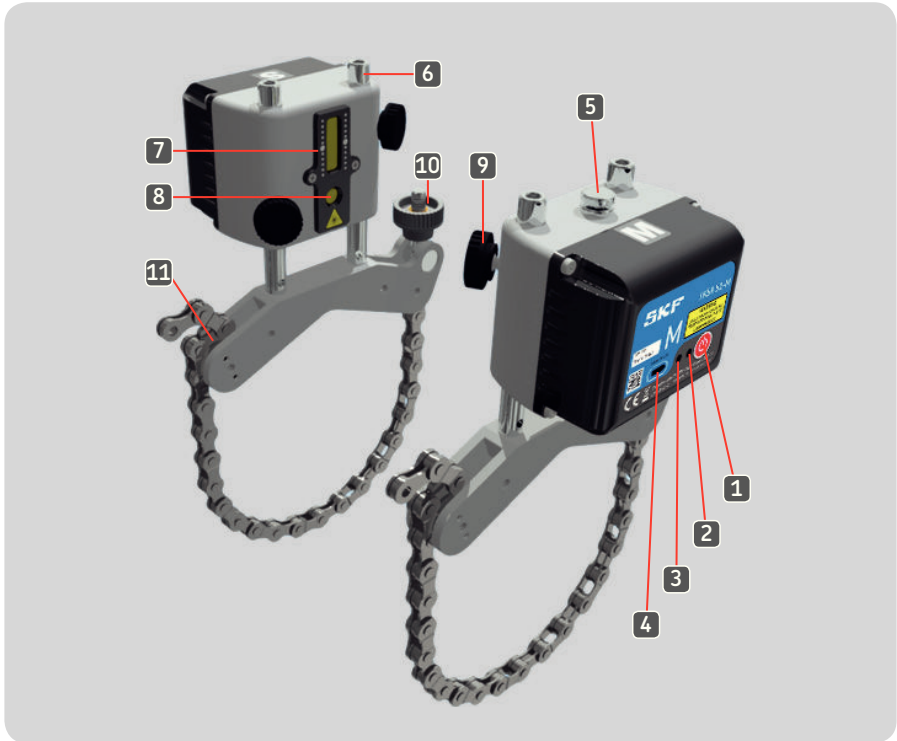

1. Power button	7. 20 mm (0.8 inch) Detector aperture and target
2. Red and green Light Emitting Diode (LED)	8. Laser aperture
3. Blue LED	9. Locking knob
4. Connector for charging (micro USB)	10. Chain tensioning knob
5. Laser adjustment knob at the M unit	11. Anchor
6. Rod	

The color functions of the Light Emitting Diodes:

- Green: Power on
- Red: Charging
- Blue: Connected

## 2.2 Handling the measuring units

- Switch on the units by pressing the power button shortly at the back of each unit.
- Press the power button until the LED switches off to turn a unit off.
- The Status LED will turn green when a unit is switched on.
- The Connection LED will turn blue when a unit is connected via Bluetooth to the app.



Charge the measuring units when the app indicates low battery:

- Plug the charger cable in the connector at the back of each unit, and the other end to a standard USB charger or a computer USB port.
- The red LED will indicate charging when the unit is off.
- The LED will go off when the battery is completely charged (about 4 hours for an empty battery).



### 2.3 Setup techniques

Measuring unit M on its shaft bracket.  
The chain is hooked from the inside for shafts with diameter  $< \varnothing 40$  mm ( $< \varnothing 1.5$  inch).

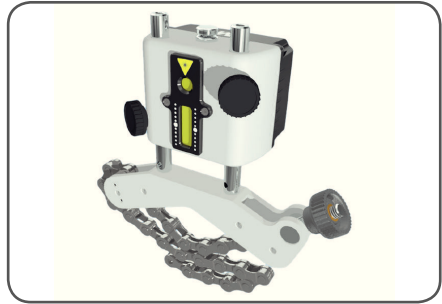

Use the extension chain for shafts  $> \varnothing 150$  mm ( $> \varnothing 6.0$  inch).  
Press both halves of the link connector together and lock in place by pulling the chain taut.

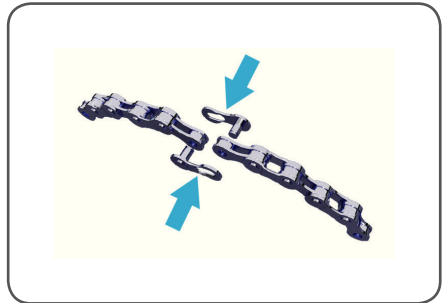

Mount the four neodymium magnets and the shaft bracket can be used as a magnetic bracket.



Align both fixtures tangentially on the coupling by using the shaft brackets, or the magnetic surface of the magnets.



## 2.4 Setup

The measuring unit marked S should be mounted on the stationary machine and the unit marked M on the movable machine.

Remove the slack of the chains, let the units face each other and tighten them firmly with the tensioning knobs.

Turn on each measuring unit by pressing the power button and start a new alignment in the app according to section 3.3 (*Main menu*). This will activate the laser beams. Now adjust the position of measuring unit S, on the rods, until its laser line hits the center of the M target. Tighten the measuring units and brackets in place with the four locking knobs.

The laser of the M unit can be adjusted with the adjustment knob at the top of the unit, to the center of the S target.



## 3. Using the App

### 3.1 App installation

The TKSA 51 system is used together with apps for the iOS platform and supports iPads, iPhones and iPads as display units. Find the app on the App Store under the name:

“**Shaft Alignment for TKSA 51**” by SKF.



### 3.2 App language & date format

The app will adapt to the language and date format currently used by the iOS device. To change these settings, tap:

*Settings --> General --> Language & Region*

### 3.3 Main menu

Start the app by tapping on the Shaft Alignment app icon, found on the home screen of the device. This will take you to the main menu.

Make sure that you have completed the instructions from section 3.1 (*App installation*).

#### a. Current alignment

If you have an ongoing alignment you will find it to the left in the main menu, named as the Current alignment.

#### b. New alignment

Tap on the plus sign (“+”) to start a new alignment. If a current alignment is in progress you will be asked if you want to start a new alignment or resume the current one.

#### c. Settings

Access the editable settings.

#### d. Help

Access help videos and the Instructions For Use document.

**e. Edit**

The reports can be deleted via Edit, which is located in the upper right corner of the view. Delete reports by tapping on Edit, then tap the reports to be deleted and finish by tapping the trash can symbol in the upper left corner of the view.

**f. Reports**

Previously created reports are shown as miniatures below the main menu buttons. Tapping a report will open it for viewing, editing, printing and e-mailing.

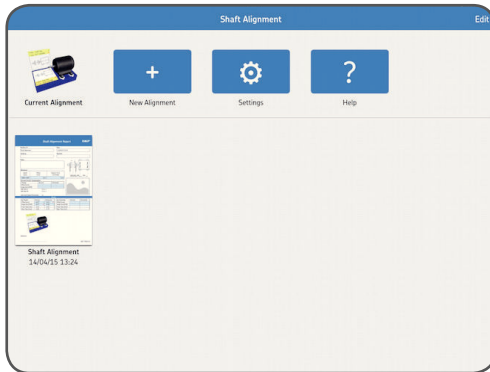

### 3.4 Settings

**a. Company, operator and logo**

Company, operator and logo is additional information that is included in generated reports.

**b. Angular error**

Angular error expressed as /100 mm (mils/inch) or as coupling gap. For gap, specify the Coupling Diameter when entering the distances in the machine Information view.

**c. Sensor values**

Sensor values is an option to display the detector readings and rotational angles during the measurement.

**d. Extended filter length**

Measurement values are filtered over time, allowing accurate measurements in the presence of external disturbances, for instance vibration. The extended filter length option enables the sample time to be increased up to 20 seconds.

**e. Hardware**

The connected measuring units. Tap Select Hardware if you want to select other units.

**f. Unit**

For the ability to change between metric and imperial measuring units. The displayed unit is normally based on the system unit, but you can override this and change between metric and imperial units.

**g. Done**

Complete any changes in settings by tapping Done.

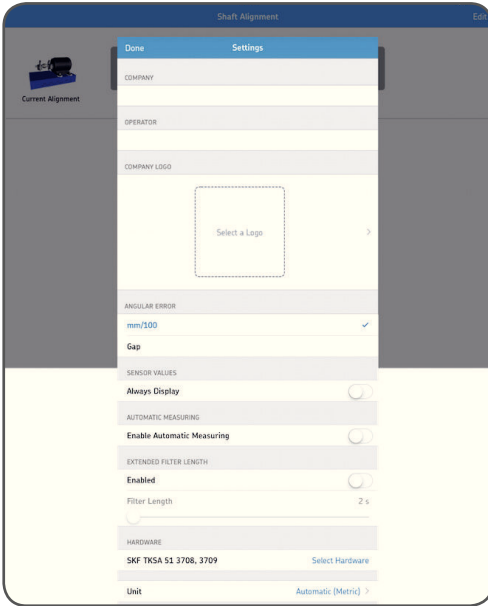



### 3.5 Select units

The Bluetooth wireless communication will establish a connection between the device and the two measuring units. You will be informed if there is a need to turn on Bluetooth on the device. Note that the first time, you have to select the measuring units that you want to use in the system.

Connect to the measuring units by tapping one S (stationary) unit and one M (movable) unit in the lists. The app will remember your chosen measuring units and will attempt to connect to these units at your next alignment.

The app features a Demo mode which allows most functionalities to be tested without having physical measuring units available.

The Demo mode option is found at the bottom of the Select units view.

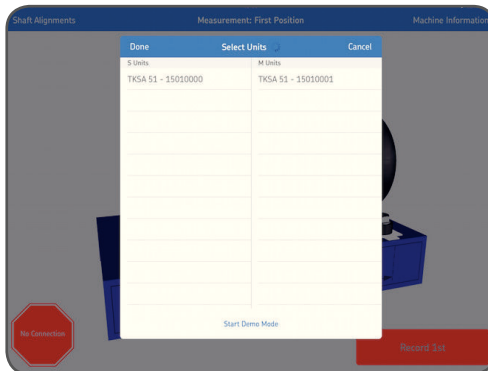

## 3.6 Machine information

The Machine information view is displayed when a new measurement has been initiated. The view is also reachable from the upper right corner of the screen while recording data in the three measurement positions.

### a. Distances

Enter the four distances for the machine to be aligned. Center of coupling is where the offset will be measured. If you want the angle expressed as the coupling gap, you also need to specify the diameter of the coupling (see the *Settings* section). Tap on the measurement to select and specify new distance measurements using the appearing keypad. The distances entered from the previous alignment will be the default values.

1. Measure and enter the distance between the center of the rods on the stationary side and the center of the coupling.
2. Measure and enter the distance between the center of the coupling and the center of the rods on the movable side.
3. Measure and enter the distance between the rods of the movable side and the front feet (center of feet).
4. Measure and enter the distance between the front and back feet (center of feet).

### b. Machine ID

Enter a machine name that will be shown in the report (optional).

### c. Photo

Add a photo of your machine for the report (optional).

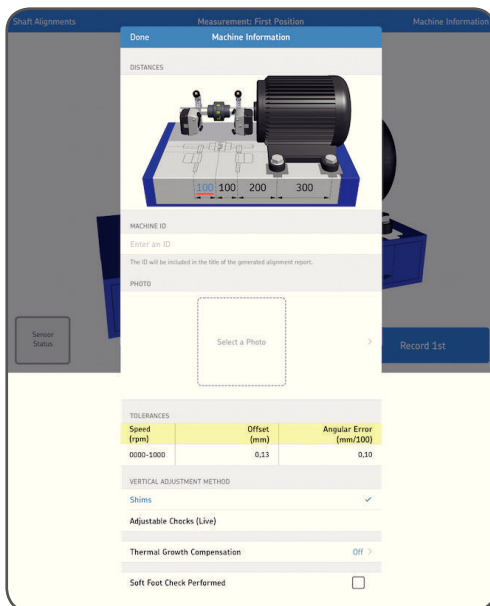

**d. Tolerances**

The built-in tolerance values can be used based on the RPM speed of the machine you are aligning. Select the appropriate tolerances by tapping the row in the table or choose custom tolerance values by tapping Edit Custom Tolerances.

**e. Vertical adjustment method - Shims**

If the vertical results are out of tolerance, there is a need to make adjustments by adding or removing shims. The system calculates the correction values at the feet and shows if shims should be added or removed. Shims values are fixed, not live. Tap Shimming Done once corrected.

**f. Vertical adjustment method - Adjustable Chocks / Vibracons (Live)**

If the vertical results are out of tolerance, there is a need to make adjustments by screwing the chocks up or down. The system shows how much the chocks need to be corrected and in which directions to make the adjustments. Choose this mode if you prefer live values.

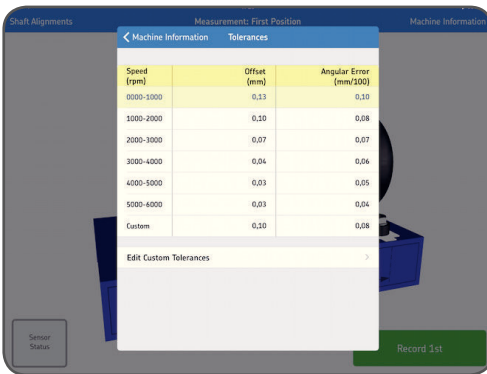

**g. Thermal growth compensation**

Enter the change in growth between off line and running temperature (normally from cold to hot position). The measurement results will be compensated so when you adjust a cold machine, having zeroed any misalignments, then the machine will be aligned when in hot condition.

**h. Soft Foot check performed**

Tap this box if a Soft Foot check was performed. A check mark indicating “Soft Foot Check Performed” will appear in the report. The Soft Foot app is found on the App Store under the name:

“Soft Foot for TKSA 51” by SKF.

**i. Done**

Complete any changes in Settings by tapping Done.

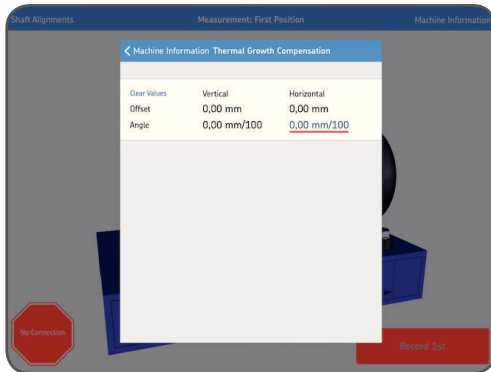

### 3.7 Sensor status

The Sensor Status appears if you have a warning or stop issue during the setup. It also appears if you tap the warning / stop sign or the Sensor status button in the lower left corner of the screen during a measurement. If a warning appears, setup assistance at the bottom of the view provides help to correct any issues. Warning signs can be ignored, but a stop sign is shown when it is not possible to read essential sensor values.

Warnings are shown when:

- Battery level is below 10% of full charge.
- Laser beam is more than 2 mm (80 mils) from the center target during the setup.
- Laser beam is too close to the edge of the detector.
- Rotational angle difference is more than 2° between measuring units.  
This is also called backlash.

Stops signs are shown when:

- There is no Bluetooth connection.
- No laser beam is detected.



#### Tip:

The Sensor status can be used to review temporary data, on the detector values and the rotation angles, during the measurement. When the results are shown, lasers are turned off and no detector values are available in this view.



**a. Serial number and connected status**

Serial number and connected status indicate if any measuring units are connected. Serial numbers are shown when units are connected or when Demo mode is chosen.

**b. Battery Level**

Indicates the charge levels for the internal batteries.

**c. Detector**

The detector values show the distances between the center of the detectors and where the laser beams hit the detectors.

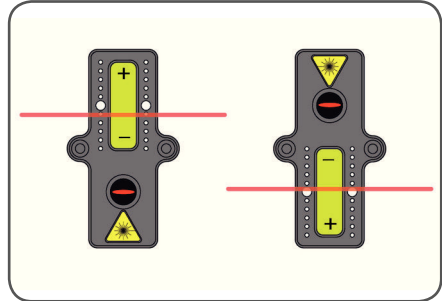

**d. Rotational angle and angle difference**

The rotational angles and angle differences can be used for precise positioning of the two facing measuring units.

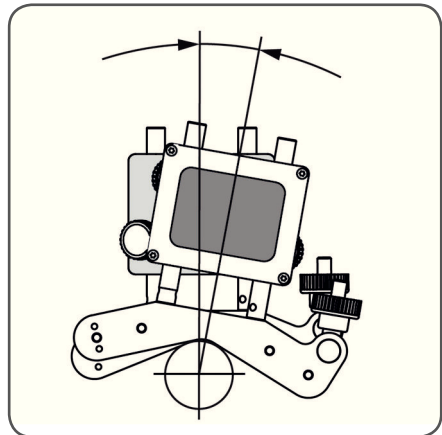

**e. Select hardware**

Lists the connected measuring units. Tap select hardware if you want to select other units.

**f. Done**

When no warnings are displayed tap Done to proceed to the measurement.

### 3.8 Measuring procedure

The default measuring procedure is to make manual measurements in the three rotational positions, described in detail further down in this section. This means that the operator turns the shaft into each position and manually taps a Record button to measure the shaft alignment data. There is also an option to let the app initiate the measurements, in the three rotational measuring positions, while the operator can focus on rotating the shaft without the need to touch the Record button for each position (see the *Settings* section to read more about enabling this option).

#### Manual measuring

Record measurements in three different rotational positions.

The system will begin with the measuring units in a horizontal position, though the 1<sup>st</sup> measurement position can be taken at any position around the shafts.

The system will offer guidance on the direction to turn, but you can turn in the opposite direction if you prefer. It is best to continue in the same direction as the first rotation for the 2<sup>nd</sup> and 3<sup>rd</sup> measurements. When the Record button turns green, the measuring unit and shaft have been rotated the ideal amount - at least 90°.

*Tap record 1<sup>st</sup>.*

A red arrow and red record button indicate that you still need to rotate the shafts before you can record the 2<sup>nd</sup> measurement position.

A blue arrow and blue record button indicate that the shafts have been sufficiently rotated (> 20°), but less than the ideal amount (90°).

If possible, continue rotating the shafts until achieving 90° rotation for best results.

No arrow and a green record button indicates that the ideal amount of rotation has been performed (90°) for best results.



### Tap record 2<sup>nd</sup>.

A red arrow and red record button indicate that you still need to rotate the shafts before you can record the 2<sup>nd</sup> measurement position.

A blue arrow and blue record button indicate that the shafts have been sufficiently rotated (> 20°), but less than the ideal amount (90°).

If possible, continue rotating the shafts until achieving 90° rotation for best results.

No arrow and a green record button indicates that the ideal amount of rotation has been performed (90°) for best results.



### Tap record 3<sup>rd</sup>.





## Automatic measuring

Record measurements in three different rotational positions.

The system will begin with the measuring units in a horizontal position, though the 1<sup>st</sup> measurement position can be taken at any position around the shafts.

The system will offer guidance on the direction to turn, but you can turn in the opposite direction if you prefer. It is best to continue in the same direction as the first rotation for the 2<sup>nd</sup> and 3<sup>rd</sup> measurements. When the Record button turns green, the measuring unit and shaft have been rotated the ideal amount - at least 90°.

*Tap start auto. This records the 1<sup>st</sup> measurement position.*

A red arrow and red auto record button indicate that you still need to rotate the shafts before the system can record the 2<sup>nd</sup> measurement position.

A blue arrow and blue auto record button indicate that the shafts have been sufficiently rotated (> 20°), but less than the ideal amount (90°).

If possible, continue rotating the shafts until achieving 90° rotation for best results.

No arrow and a green auto record button indicates that the ideal amount of rotation has been performed (90°) for best results.

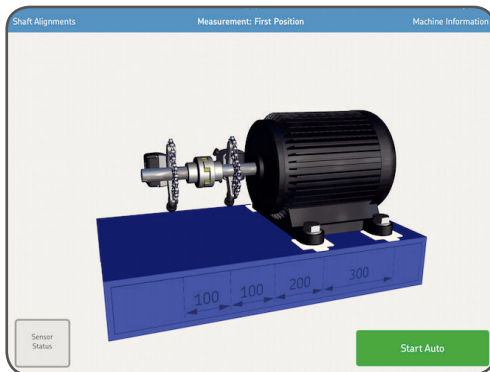

*When the system senses that the shaft has been rotated sufficiently, and has been left untouched for a short while, it will automatically record the 2<sup>nd</sup> measurement position.*

A red arrow and red auto record button indicate that you still need to rotate the shafts before the system can record the 3<sup>rd</sup> measurement position.

A blue arrow and blue Auto Record button indicate that the shafts have been sufficiently rotated ( $> 20^\circ$ ), but less than the ideal amount ( $90^\circ$ ). If possible, continue rotating the shafts until achieving  $90^\circ$  rotation for best results.

No arrow and a green Auto Record button indicates that the ideal amount of rotation has been performed ( $90^\circ$ ) for best results.

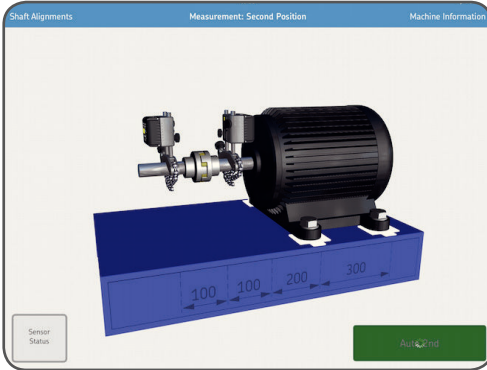

*When the system senses that the shaft has again been rotated sufficiently, and has been left untouched for a short while, it will automatically record the 3<sup>rd</sup> measurement position.*

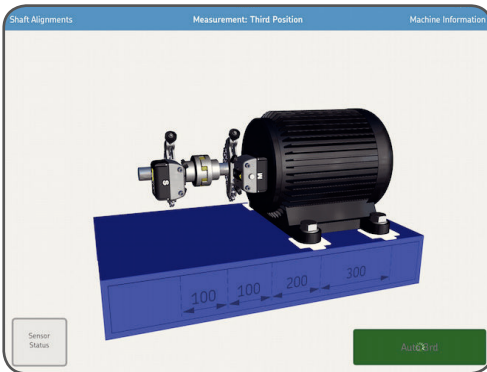

### 3.9 “As found” measuring results

The parallel offset and angular misalignment results for the vertical and horizontal axes, or planes, are shown in a combined view. Graphics show the position of the machine from a side and a top view.

#### a. Remeasure

If required, select Remeasure to cancel the results and make a new set of measurements.

#### b. Adjust

Perform vertical and horizontal corrections. The green adjust button indicates that some values are out of tolerance and correction is needed.

#### c. Alignment done

Accept the results by tapping alignment done. This creates a report which is placed below the main menu. Note that it is possible to resume the alignment after alignment done has been selected.

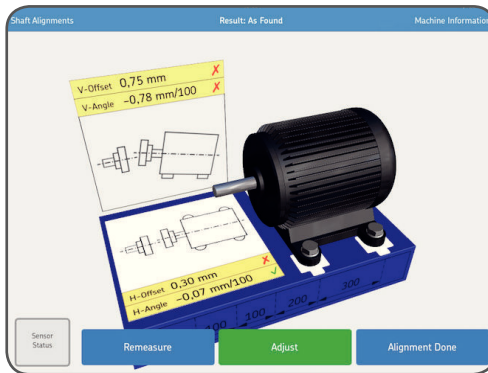

The values are compared with the selected tolerances and the symbols to the right, of the offset and angular misalignment values, indicate if the values are within tolerance.

Within tolerance: ✓

Out of tolerance: ✗

### 3.10 Vertical correction

If the vertical results are out of tolerance, you need to correct the shimming or the adjustable chocks. Based on the offset and angular misalignment values, the system calculates the correction values at the feet.

An animation shows the bolts being loosened in order to make corrections.

In the Machine Information view you can set the vertical adjustment method.

#### a. Vertical adjustment method - Shims

If the vertical adjustment method in the Machine Information is set to shims, the system will show if shims should be added or removed.

After the correction, or if no correction is needed, tap Shimming Done.



#### b. Vertical adjustment method - Adjustable Chocks (Live)

If the vertical adjustment method in the machine information is set to adjustable chocks, the screen will show vertical correction values.

Set the measuring units in a vertical position for live adjustment.

After the correction, or if no correction is needed, tap Adjustment Done.

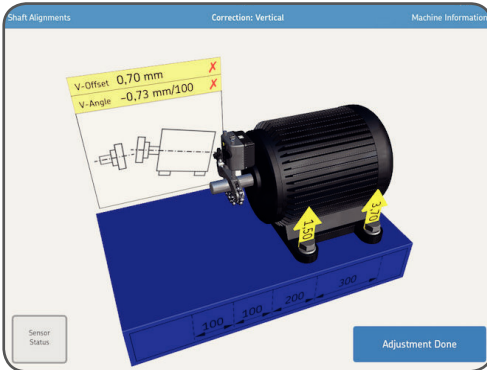

### 3.11 Horizontal correction

Based on the offset and angular misalignment values, the system calculates the correction values at the feet of the moveable machine.

When the units are in a horizontal position then the horizontal values are live values.

Move the machine according to the arrows and observe the offset and angular misalignment values that are updated continuously.



After the correction, or if no correction is needed, tap Adjustment Done.

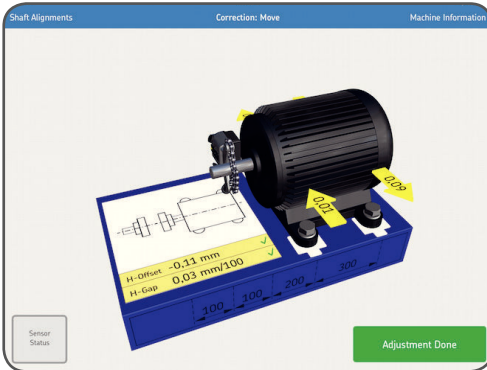

An animation shows the bolts being tightened down. Alignment is now complete and to confirm the result there is a need to re-do the measurement. Tap Remeasure.



### 3.12 Verify the alignment

The system requires that a new measurement is made to verify the alignment. This step is mandatory.

### 3.13 “As corrected” measuring results

When the Alignment Done button is green, the machines are aligned within the chosen tolerances. If this is not the case, tap Adjust to correct the misalignment. Tap Alignment Done to exit to the main screen and to automatically create a report.

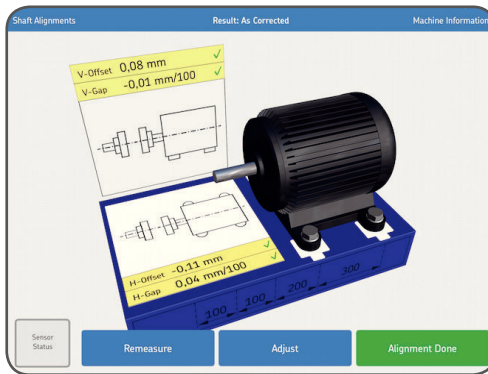

### 3.14 Report

The reports are automatically generated as PDF files and they are displayed on the main menu, with the most recent alignment in the upper left corner. A report automatically contains measuring data for both the “As found” and “As corrected” results when a complete alignment has been performed.

#### a. Edit report

The report contains information from the measurement and can be completed with additional information. Tap anywhere in the report to edit.

#### b. Signature

Tap the Signature field and write your signature in the opening Sign Report view. If a signed report is to be edited then the editor will be informed of a signature removal. The user will have to confirm this before editing is possible.

## Shaft Alignment Report SKF

Machine ID:  Date:

Company:  Operator:

Notes:

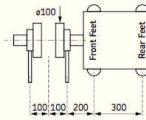

Tolerances		
Speed (rpm)	Offset (mm)	Angular Error (mm/100)
0000-1000	0,13	0,10

Thermal Growth Compensation		
Change	Vertical	Horizontal
Offset (mm)	-	-
Gap (mm)	-	-

S/N Unit S: 3708  
S/N Unit M: 3709

Soft Foot Check Performed: No

Result					
As Found	Vertical	Horizontal	As Corrected	Vertical	Horizontal
Offset (mm)	0,06	-0,99	0,08	-0,11	0,02
Gap (mm)	-0,02	0,34	-0,01	0,04	0,02
Front Feet (mm)	-0,00	0,04	0,04	0,02	0,02
Rear Feet (mm)	-0,07	1,07	-0,00	0,15	0,15

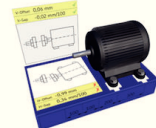
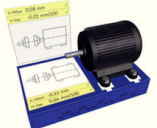
Signature: \_\_\_\_\_





SKF TKSA 51

### c. Share report

While viewing a report it is possible to share it through for instance email or by printing it. The sharing functionality is available in the upper right corner of the view.

Shaft Alignments
Shaft Alignment

## Shaft Alignment

Machine ID:  Date:



Company:  Operator:

Notes:

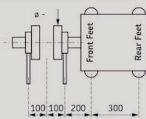

Tolerances		
Speed (rpm)	Offset (mm)	Angular Error (mm/100)
0000-1000	0,13	0,10

Thermal Growth Compensation		
Change	Vertical	Horizontal
Offset (mm)	-	-
Angle (mm/100)	-	-



## 4. Technical specifications

Technical data	
Designation	<b>TKSA 51</b>
Description	SKF Shaft Alignment Tool TKSA 51

Measuring units (MU)	
Sensors type	20 mm (0.8 in.) PSD with red line laser Class 2
Electronic inclinometers	Yes, $\pm 0,1^\circ$
Communication	Wireless, Bluetooth 4.0 LE (up to 10 m (32.8 ft) range)
Housing material	Anodized aluminum front and PC/ABS plastic back cover
Colours	SKF product grey and silver aluminum front
Dimensions (H x W x D)	52 x 64 x 50 mm (2.1 x 2.5 x 2 in.)
Weight	190 g (0.4 lbs)
Measuring distance MU	0,07 m to 5 m (0.23 to 16.4 ft)
Measuring errors	< 1% + 1 digit

Operating device	
Operating device	Not supplied
Software/App update	via Apple Store
Operating devices compatible	iPad Mini or Ipad 3rd generation minimum iPod Touch 5th generation minimum iPhone 4S minimum iPad mini recommended
Operating system requirements	Apple iOS 8 or above

<b>Mounting brackets</b>	
Fixture	2 × V-brackets with chains and magnets
Material	Anodized aluminum with steel pin
Chains Supplied	480 mm (18.9 in.) mounted on brackets plus 1 m (3.3 ft) extensions chains supplied (total of 1,5 m (5 ft))
Rods supplied	2 × 80 mm (3.2 in) threaded rods per bracket & 4 × additional 120 mm (4.7 in.) threaded rods
Shaft diameters	20 to 150 mm diameter (0.8 to 5.9 in.) with standard chains (450 mm (17.7 in.) with extension chains supplied)
Max. recom. coupling height	170 mm (6.7 in.) with extension rods (unit should be mounted on the coupling when possible)
Brackets V-base width	15 mm (0.6 in.)

<b>Features</b>	
Alignment method	Alignment of horizontal shafts 3 × positions free measurement (min. 40° total angle)
Automatic measurement	Yes
Vertical correction (shiming)	Yes, live values. Adjustable shocks compatible (vibracons)
Live horizontal correction	Yes
Soft foot correction	Separate Soft Foot App
Thermal growth compensation	Yes
Machine view	Free 3D rotation
QR codes reading	No
Report	Automatic .pdf report (exportable via email/cloud services)
Digital camera	Yes, if available on operating device
Display orientation	Landscape (plus portrait on tablets)

<b>Power and battery</b>	
MU Operation time	10 hours continuous use 2 000 mAh rechargeable Li-ion battery
DU Operating time	N/A
Power adapter	Charging via micro USB port (5V) Micro USB to USB split charging cable supplied Compatible with 5V USB chargers (not included)
System charging time	~4 hours (with 1A supply) 90% in 2 hours

<b>Size and weight</b>	
Carrying case dimensions	355 × 250 × 110 mm (14 × 9.8 × 4.3 in)
Total weight (incl. case)	2,9 kg (6.4 lbs)

<b>Operating requirements</b>	
Operating temperature	0 °C to +45 °C (32 to 113 °F)
Storage temperature	-20 °C to +70 °C (-4 °F to +158 °F)
Relative humidity	10% to 90% non condensing
IP rating	IP 54

<b>Case contents</b>	
Calibration certificate	Supplied with 2 years validity
Warranty	2 years standard warranty (1 year extra upon registration)
In the case	2 × TKSA 51 Measuring units
	2 × Shaft brackets with chains and magnets
	4 × 120 mm extension rods
	2 × Extension chains of 980 mm for shaft up to 450 mm diameter
	1 × Micro USB to USB split charging cable
	1 × 2 m metric and imperial measuring tape
	1 × Printed certificate of calibration and conformance
	1 × Printed quick Start guide (English)
	1 × SKF Carrying case

Spare parts and accessories	
Designation	Description
TKSA 51-M	1 × TKSA 51 M Measuring Unit (incl. Calib. certif.)
TKSA 51-S	1 × TKSA 51 S Measuring Unit (incl. Calib. certif.)
TKSA 51-VBK	1 × Standard chain bracket incl. 80 mm (3.2 in.) threaded rods & 1 × standard chain 480 mm, incl. 4 × magnets
TKSA 51-EXTCH	2 × Extension chains of 1 m (3.3 ft) for shaft up to 450 mm (17.7 ft) diameter
TKSA 51-ROD120	4 × threaded 120 mm (4.7 in.) extension rods
TKSA 51-ROD80	4 × threaded 80 mm (3.2 in.) extension rods
TKSA 51-SLDBK	1 × Sliding adjustable bracket (no rods) for use with shaft > 30 mm or bore > 120 mm
TKSA 51-EXT50	1 × 50 mm (2 in.) offset bracket with 2 × rods 80 mm (3.2 in.)
TKSA 51-SPDBK	1 × Spindle Bracket with 2 × rods 80 mm (3.2 in.)







The contents of this publication are the copyright of the publisher and may not be reproduced (even extracts) unless prior written permission is granted. Every care has been taken to ensure the accuracy of the information contained in this publication but no liability can be accepted for any loss or damage whether direct, indirect or consequential arising out of the use of the information contained herein.

